

MY 139' Adventure Yacht



MY 139' Adventure Yacht

Naval Architects : Gregory C. Marshall Naval Architect Ltd
Interior and Exterior Design : TBD

LOA 42.24 metres (139')
LWL 40.8 metres
BOA 8,6 metres
Draft 2,50 metres
Displacement 285 T Half Load
GRT 306 GRT
Top Speed - Cruising speed 22,5 knots - 20 knots
Range 4 000 nm at 14 knots

Construction Aluminium hull & superstructures
Classification BV and MCA
Owner and Guest capacity 8 pers
Crew Capacity 6 –7 pers

Main engine 2 x 2895 Hp MTU
Genset 2 x 80 kW Kohler
Fuel capacity 103 000 L
Fresh water capacity 9 360 L
Grey water 6 409 L
Black water 3 078 L

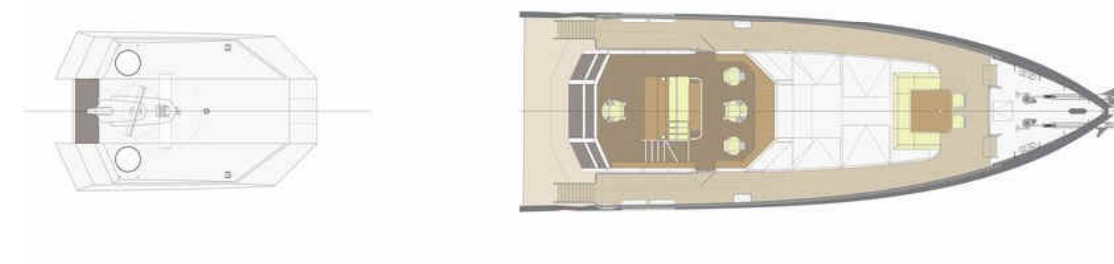

MY 139' Adventure Yacht



MY 139' Adventure Yacht



MY 139' Adventure Yacht



MY 139' Adventure Yacht

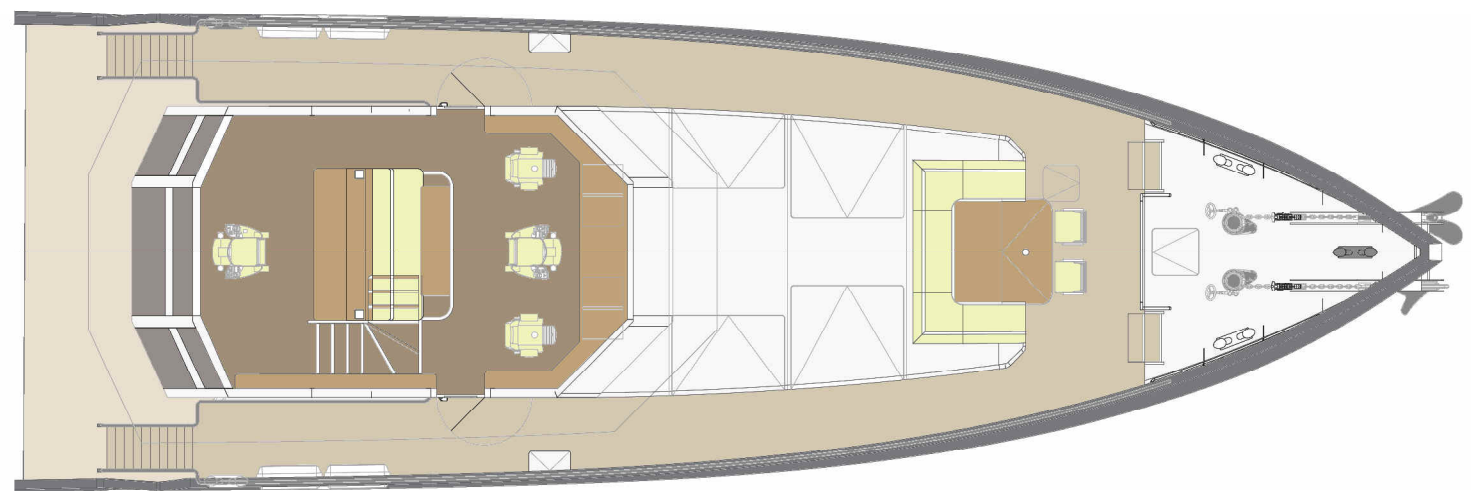
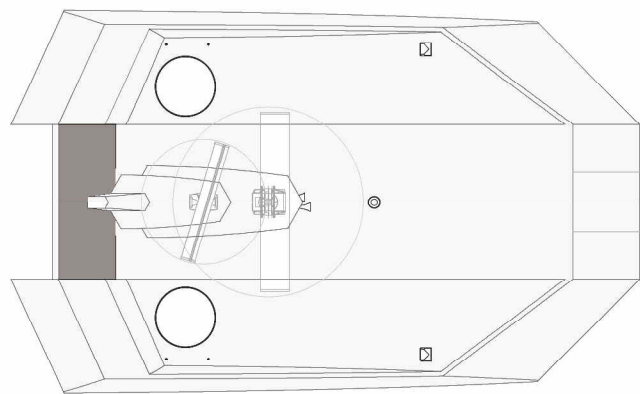
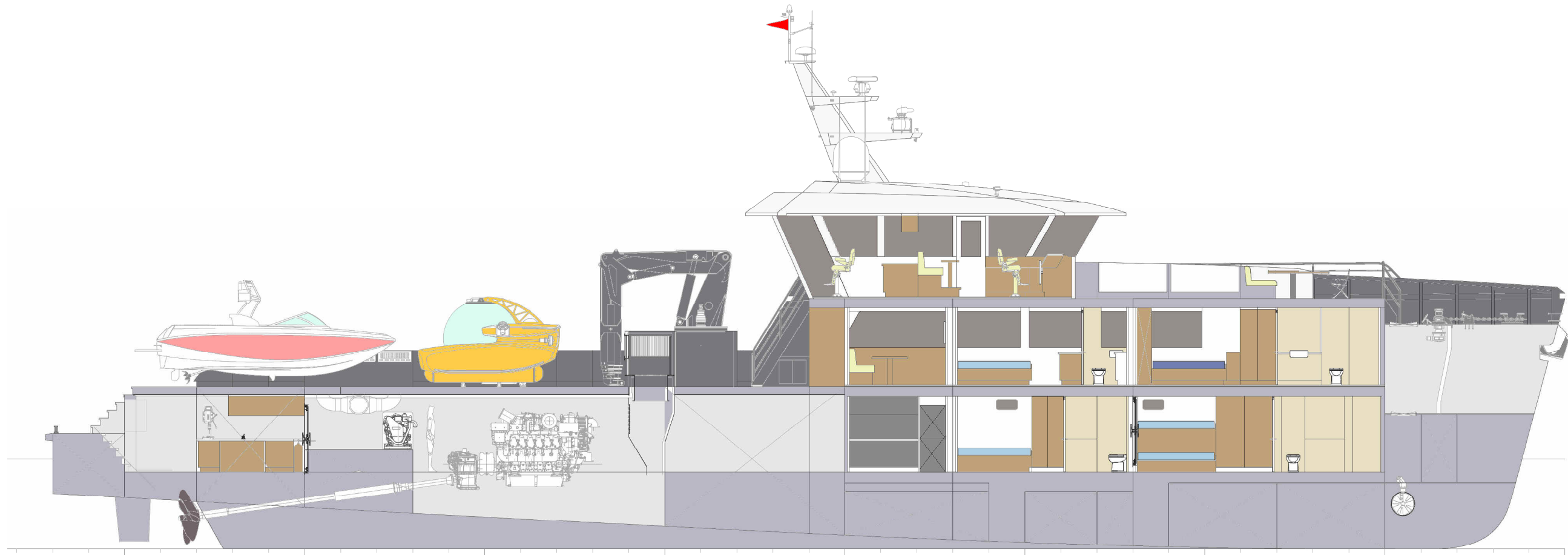

MY 139' Adventure Yacht

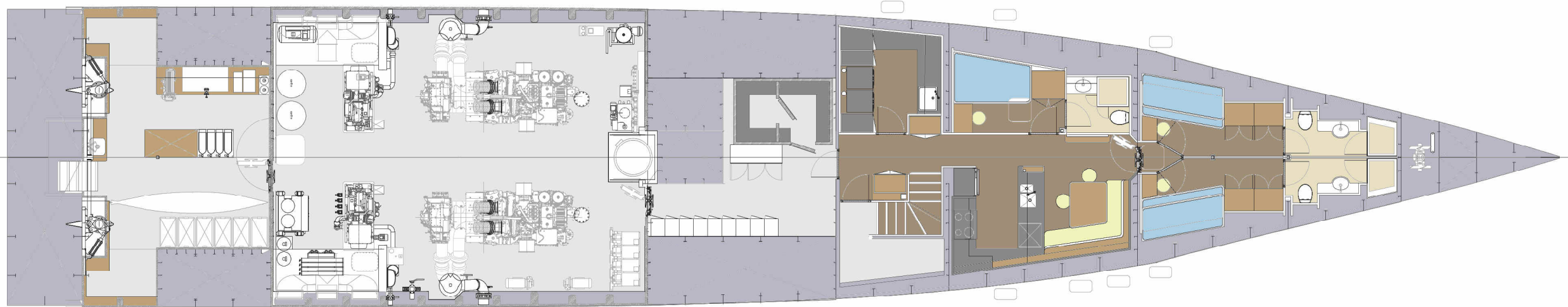
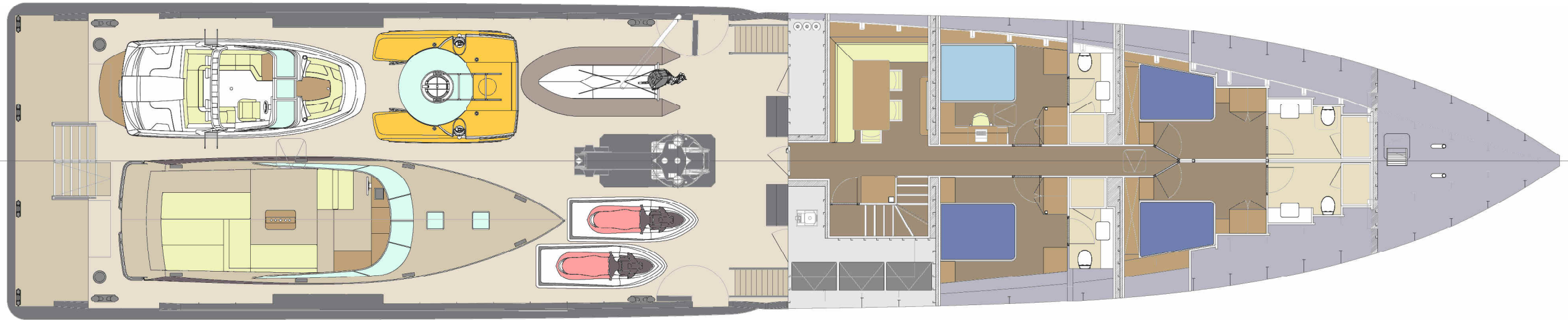

MY 139' Adventure Yacht



MY 139' Adventure Yacht

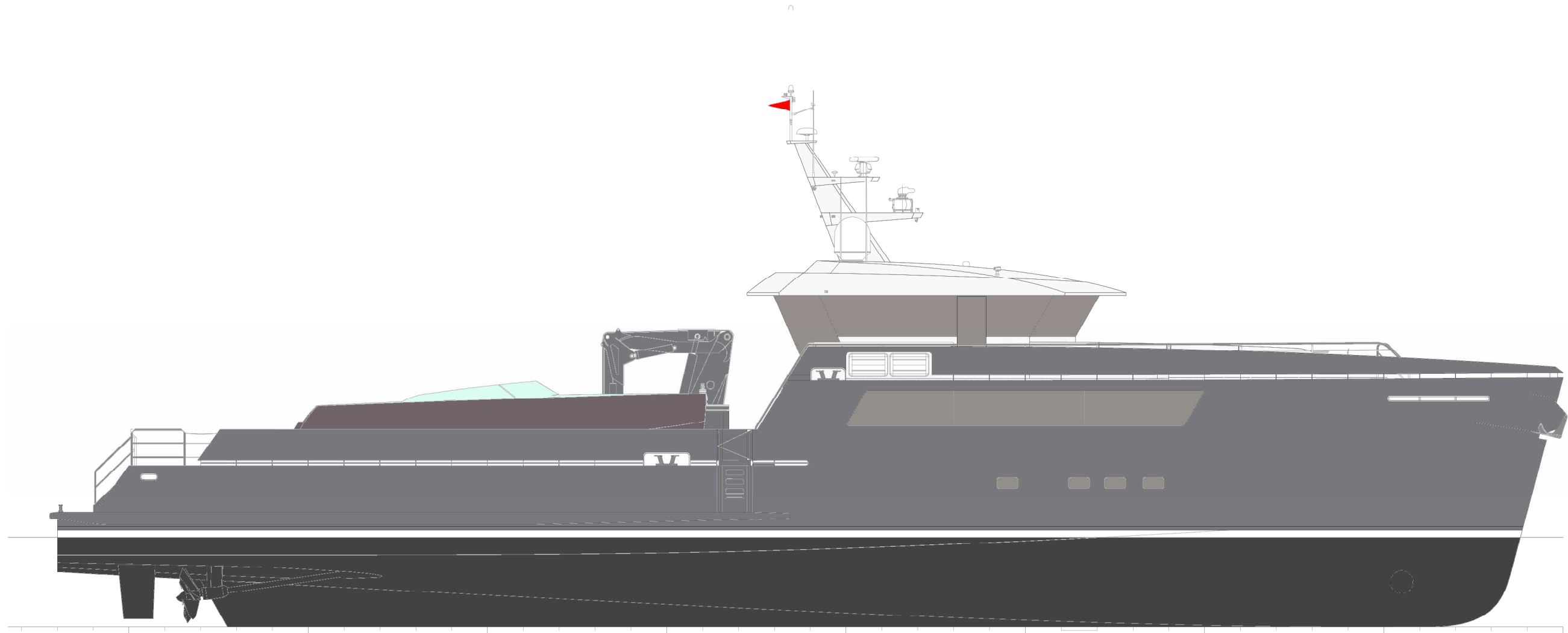

NAVAL ARCHITECT : Gregory C. Marshall Naval Architect Ltd

<http://www.gregmarshalldesign.com>

GREGORY C. MARSHALL
NAVAL ARCHITECT LTD.

